

# Table of Contents

<b>1</b>	Precautions .....	1
<b>2</b>	Features .....	2
<b>3</b>	Technical Data .....	8
<b>4</b>	Installation Guide .....	9
<b>5</b>	Dome Settings .....	12
<b>6</b>	Operation Instructions .....	16
<b>7</b>	After- sales service.....	51
<b>8</b>	APPENDIX .....	52

# 1 Precaution

***\*Please read this manual carefully before the installations and operations.***

## ●Transportation Security

No heavy stress, violent vibration or water splash are allowed during transportation, storage. The unit should be transported in separated packing. In shipments of distributor and delivery of maintenance, any damages caused by integral packing are not covered by warranty.

## ●Installation

Avoid heavy stress and violent vibration during installation. Don't touch the dome cover directly by hand. When connecting the power source, please follow all electric safety standards and only use the power supply designated for this device. Keep the video and control signal in a decent distance from high voltage devices and cable. Don't apply power to dome before finishing the installation.

## ●Internal Environment

Keep metal and inflammable material away from dome body to avoid fire short circuit and damage. Please prevent all liquids material from entering the dome. If this occurs, please shut down the power and pull out the plug-in. Then please inform the technical personnel immediately.

## ●Electrical Safety

The video image would be interfered when the dome is installed near Television, radio transmitter, voltage changer and audio amplifier.

## ●Camera Protection

Avoid shooting very bright objects directly into the camera's SEMSOR (such as the sun or light fittings) and avoid fixating the camera lens on bright static object for long time, as it will cause Irreparable damage to the camera's SEMSOR.

## ●Cleaning Method

Please don't use abrasive and violent detergent to clean the dome. Please choose dry fabric and neutral detergent. And please use lens paper to clean the lens.

***\*Internal removing, assembly, repair and operations should be only performed by qualified service personnel.***

**●Please use our production under the following environmental standards:**

Environmental Temperature:	-35 ~60 °C
Environmental Humidity:	<95%
Barometric Pressure:	86~106KPa
Power Supply:	DC12V/4A

## 2 Features

### ● Main Features

- Stepless speed changes, auto zoom/speed matching
- Pan 0.01~360°/S, Tilt 0.01°~120°/S, Preset: 360°/S (high speed IR speed dome)
- Pan 0.5°~35°, Tilt 0.5°~35°, Preset:35°/s (for Vari-speed IR dome)
- Auto object track with zoom in/out and motion detection (Auto Track Model)
- Timing actions for 7 days of programmable schedule
- Built-in Semi-conductor heater & digital temperature sensor
- PWM cooling fan vari-speed temperature control
- Reserved network interface and space for network module
- Pan Tilt accuracy +/- 0.1°, 256preset positions
- 8 cruising tracks, each cruising track has 32 presets
- 4 pattern tours,10 Mins memory, 500 programmable instructions
- Multi-Protocol through RS485 or coaxial cable.
- 8 auto scan with use-defined left and right boundaries and settable scan speed
- 8 Privacy Zones with defined English camera title
- Auto Compatible PELCO\_P, PELCO\_D compatible
- Support coaxial control
- Guard Location: the dome will rotate back to preset position after a period of vacant time
- Alarm triggering: the alarm can trigger preset, auto scan, cruising and pattern tours functions
- Soft Address Function: the use can set up the dome address without uninstall the dome

### ● Integrated Super Speed PTZ Rotator

- Delicate stepping motor, stable, sensitive and accurate
- 360° Pan and 90° Tilt range (auto-flip) without blind area
- Stepless speed change, auto zoom/speed matching
- Near / far IR Light auto matches camera zoom in/out

### ● Built-in High Definition Day/Night Camera

- Auto iris, auto back light compensation
- Auto/manual white balance
- Auto/manual brightness control
- Auto/manual focus
- Multiple compatible camera brands including TVI,AHD,CVI module .

### ● All-weather Outdoor Design

- 6 Inch High die-cast alloy aluminum construction
- High Precision Mould with high heat conductivity
- Fully enclosed isolation design for heat sink

- Nanometer Dustproof, waterproof and fog-proof lens
- IP66 Waterproof
- 3000V lightning and surge current protection

### ● **Function Instructions**

- **Focus / PTZ Speed Auto Match**

The pan/tilt rotation speed could be automatically adjusted according to the focus in/out, which makes it much more practical for manual target tracking. (Only for the auto tracking IR speed dome)

- **Auto Flip**

When the camera tilts downward and goes just beyond the vertical position, the camera will rotate 180 degrees.

- **Preset Position Set up and Call Up**

In the Preset function the dome stores the current pan/tilt angle, zoom and other position parameters in its memory. When necessary the dome recalls these parameters and adjusts the camera to a particular position. The user can store, recall and clear the presets easily and promptly by using the keyboard controller. The dome can store up to 220 presets.

- **Auto Scan**

Users can set up the left and right boundaries by control keyboard. Then speed dome can scan between this boundary. It supports up to 8 groups of scanning paths.

- **Cruising Track**

The preset position can be programmed to be recalled in a set of sequences. This sequence can be set to let the camera scan from one position to the next in a cycle at a set speed. This feature is called the "auto cruise". The cruise sequence and dwell time of each preset can be set. It supports up to 8cruising tracks, each cruising track with 32 presets.

- **Pattern Tour**

Dome can memorize 600S running path or 500 programmable instructions. When start pattern tour, speed dome will move automatically according recorded action path. It supports 4 groups of pattern tours.

- **Guard Location**

The dome automatically return to preset position if there is no operation in period of vacant time.

- **Default Action**

When you start up the dome camera or do not send commands over a long time, the dome camera will return to its default functions which include the home place, auto pan, auto cruise and

pattern.

- **Dome Address Setup**

The dome supports up to 256 addresses and the dome will only response to the instructions given to its own address. Please check the dip switch on the bottom of the dome for address setup.

- **Manual Object Tracking**

The use can move the joystick up, down, left or right to track the appearing object in the screen and use the joystick to zoom in and out with auto focus.

- **Privacy Mask Protection**

Set black mask areas to protect the privacy zones. The black privacy locations can be set, and support up to 8 mask zones.

- **Timing Running Function**

Users can set speed dome operation task at total 8 timing areas during 7 days.

- **Coordinates and Directions Display**

User can define the dome's direction of due north, which will help to show up the exact moving directions on screen. And zone title is supported to display when the dome moves to the specified zone.

- **Motion Detection**

The dome will detect the changes in the defined video zone and trigger alarm. It supports to 8 video Locations, each with 4 detection zones.

- **PTZ and Lens Control**

- 1) Zoom Control

Users can control zoom by keyboard to get near or far images.

- 2) Focus Control

The default setting is auto focus. The camera will auto focus based on the center of the video display to get the clear image. In some special occasions, the user could do the manual focus to get the desired image effect.

- 3) Auto Iris Control

Auto Iris is aiming to detect the environmental lights condition and adjust the iris to get the stabilized brightness of the image.

- 4) Auto Back Light Compensation

In the highly bright background, auto back light compensation is aiming to compensate the brightness of the dark object and adjust the background brightness to get a clear image.

- 5) Auto/Manual White Balance

Auto/Manual WB adjust depending on the environment light changes.

6) Day and Night Switch (Only for Day/Nigh Camera)

Speed dome camera can auto switch according to the environmental illumination changes.

7) OSD Setup (Only for camera with menu)

Call upon preset No.95 to enter into OSD menu setup interface. Press "Focus" to choose menu items and press "Iris" to set menu contents.

# 3 Technical Specifications

<b>Power Supply:</b>	DC12V±10% 50W
<b>Night IR Distance:</b>	120/150/180meters
<b>Manual Speed:</b>	Pan:0.01°~360°/S, Tilt: 0.01°~120°/S (high speed) Pan:0.5°~35°/S, Tilt:0.5°~35°/S (Vair-speed)
<b>Preset Speed:</b>	360°/S (high speed) / 35°/S (Vari-speed)
<b>Pan Angle:</b>	360° continuous pan rotation
<b>Tilt Angle:</b>	90°(Auto Flip)
<b>Number of Preset:</b>	256
<b>Preset Accuracy:</b>	±0.1°
<b>Auto Scan:</b>	8 auto scan tracks, user-defined left and right boundaries and scan speed
<b>Auto Cruising:</b>	8 cruising tracks, each cruising tracks has 32 preset positions, user-defined dwell time
<b>Pattern Tour:</b>	4 patterns, up to 500 instructions per pattern
<b>Guard Location:</b>	The dome will rotate back to preset position after a period of vacant time.
<b>IR LED On Mode:</b>	Manual/Auto/Timing
<b>Data Communication:</b>	RS-485, Coaxial control
<b>Protocols:</b>	Coaxial control or RS485: Auto Compatible PELCO_P, PELCO_D
<b>Camera Module:</b>	Auto Compatible TVI,AHD,CVI module.
<b>Baud Rate:</b>	2400/4800/9600bps
<b>Operating Humidity:</b>	0~90%
<b>Operating Temp:</b>	-35 °C ±55°C

# 4 Installation Guide

## ● Preparations

### • *Basic Requirements*

All the electric work must be finished under the latest electric & fire prevention law and rules (and any related law and rules). Please check according to the packing list if every accessory is included. And also make sure the installation is operated as required. Please contact us for any help during the installation.

### • *Installation Space and Density Checkup*

Please make sure the space is big enough to install our dome. And also ensure the density of the ceilings or walls to hold total weight of the dome and its accessories.

### • *Cables Preparation*

Please choose the proper cable according to the transmission distance. The min requirement of coaxial BNC cable is listed as follows for reference:

Models	Max Distance(Feet\Meter)
RG59/U	750ft(229m)
RG6/U	1,000ft(305m)
RG11/U	1,500ft(457m)

## ● Installation Method

The IR speed dome could be installed in wall-mount and pedant-mount

## ● Installation Dimensions



•Wall Mount

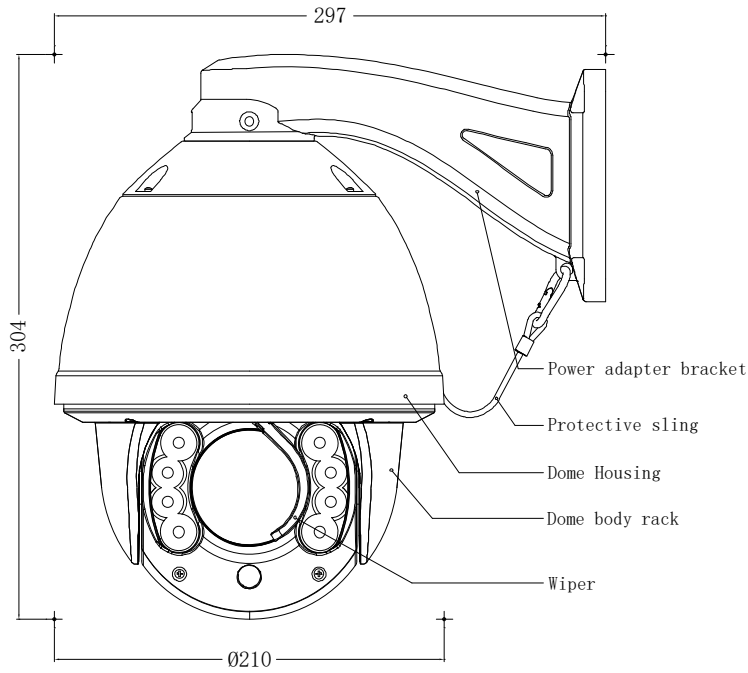

Picture01

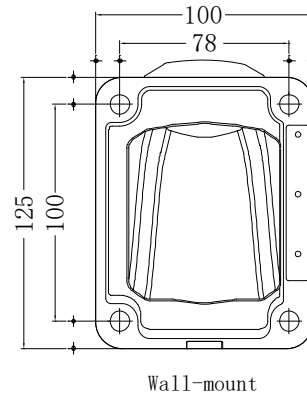

picture02

•Pendant Mount

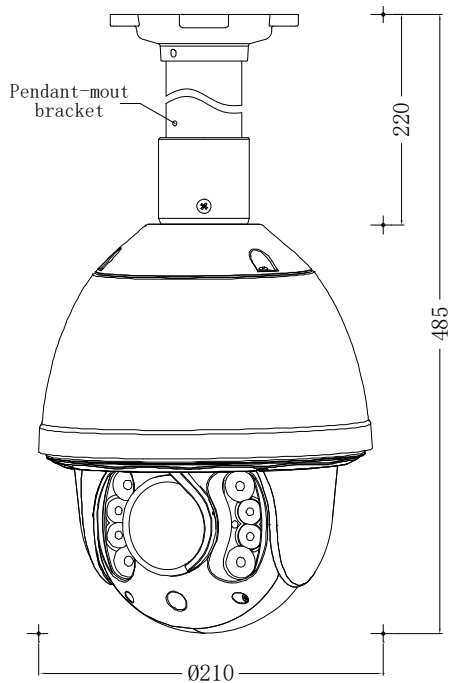

Picture03

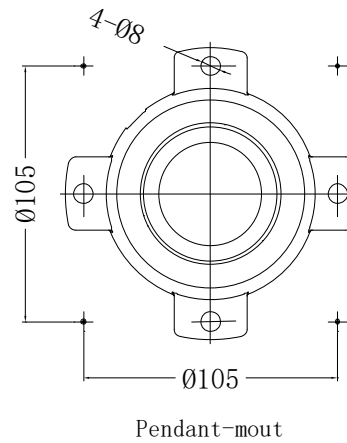

picture04

●Installation Procedures

**Notice:** The wall and ceiling must be thick enough to install the expansion bolts and can bear 4 times the weight of the dome camera itself.

★ **Wall-mount Installation Procedures:**

- 1) Take out the wall-mount bracket from the package , mark the installation hole positions on the wall referencing to the dimension as **picture 02**.
- 2) Drill the hole and install 4 pieces of M8 expansion bolt into the hole.

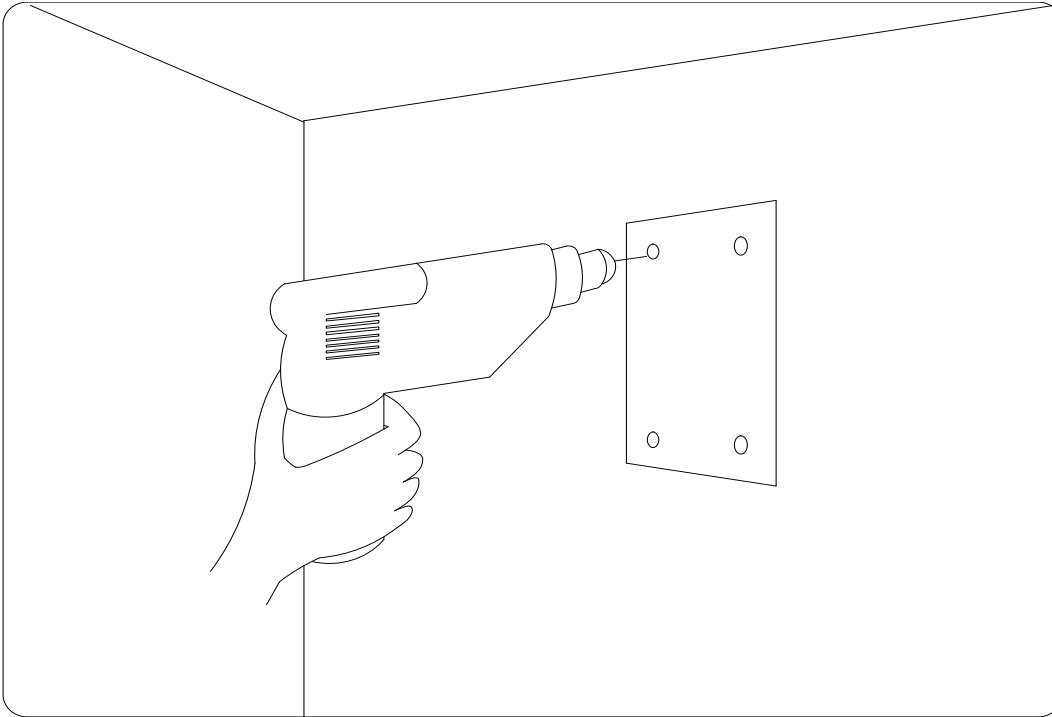

(Picture 05)

- 3) Take out the IR speed dome and put the cables through the bracket. Use M5 screws to fix the bracket and dome body, as **picture 01**
- 4) Use 4 pieces of M8 screw nuts with washer to fix the bracket on the wall.

★ **Pendant-mount Installation Procedures:**

- 1) Take out the pendant-mount bracket from the package , mark the installation hole positions on the ceiling referencing to the dimension in **picture 04**.
- 2) Drill the hole and install 4 pieces of M8 expansion bolt into the hole, as **picture05**
- 3) Take out the IR speed dome and put the cables through the sockets on the bottom of the pendant bracket. Use M5 screws to fix the bracket and dome body, as **picture 03**

4) Use screw nuts with washer to fix the bracket on the wall.

**Notice: Pendant-bracket is not designed for outdoor installation. If specially required, please do make sure the waterproof installation of the dome.**

## 5 Dome Setting

Before the dome is installed, please finish the setup of the communication protocol, baud rate and dome address. Set the DIP switch inside the dome body. The relative DIP switch site and connecting wires are diagrammed below for reference.

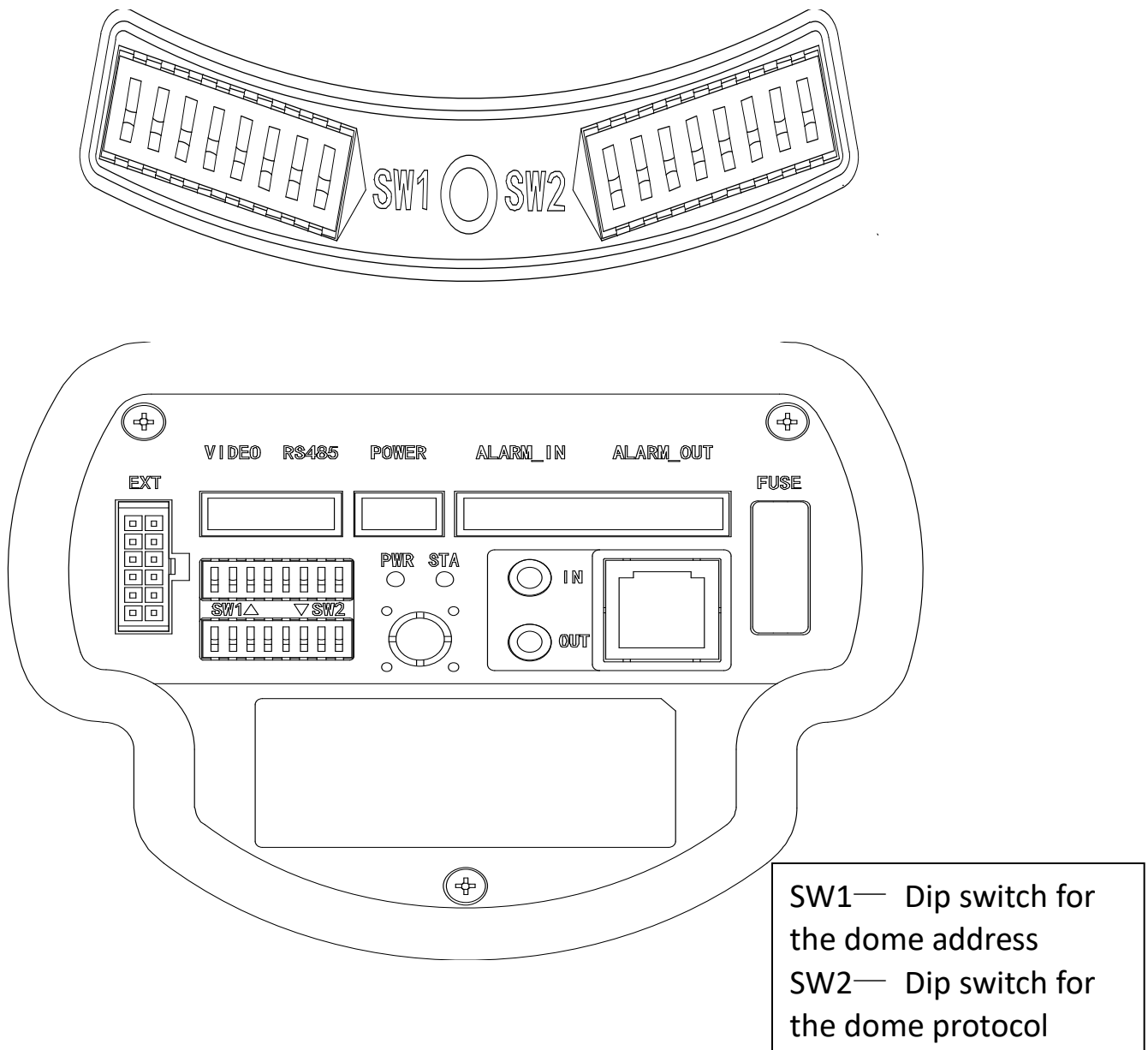

## ● Protocol Setup

Customers can use coax control or RS485 control.

### coax control:

- 1: If the customer uses the AHD mode, you need to select the PELCO coaxial protocol.
- 2: If the customer uses the CVI mode, you need to select the DAHUA coaxial protocol
- 3: If the customer uses the TVI mode, you need to select the HIKVISION coaxial protocol

By calling twice times 2 preset number, one time 15 preset number switched video mode, dome Will display menu like this:

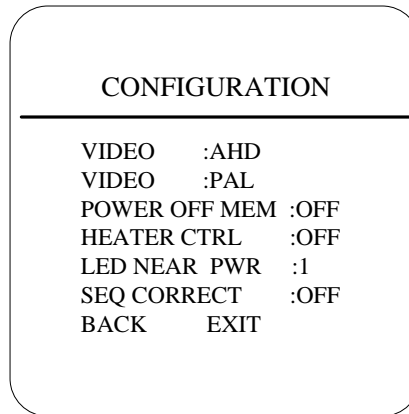

### RS485 control:

Our IR speed dome supports three protocols including Pelco P, Pelco D and HS. All of them supports baud rate of 9600bps、4800bps、2400bps. Set the No.1~4 dip switch for the protocol configuration.

Protocol	SW2-1	SW2-2	SW2-3	SW2-4
HS	OFF	OFF	OFF	OFF
PELCO P	ON	OFF	OFF	OFF
PELCO D	OFF	ON	OFF	OFF
Reserved	...	...	...	...

## ● Baud Rate Setup

Set the No.5~6 dip switch for the baud rate configuration.

Baud Rate	SW2-5	SW2-6
9600	OFF	OFF
4800	ON	OFF
2400	OFF	ON
Reserved	...	...

### ●Dome Address Setup

#### PELCO-P & PELCO-D Protocol

Add	SW-1	SW1-2	SW1-3	SW1-4	SW1-5	SW1-6	SW1-7	SW1-8
1	1	0	0	0	0	0	0	0
2	0	1	0	0	0	0	0	0
3	1	1	0	0	0	0	0	0
4	0	0	1	0	0	0	0	0
5	1	0	1	0	0	0	0	0
6	0	1	1	0	0	0	0	0
7	1	1	1	0	0	0	0	0
8	0	0	0	1	0	0	0	0
9	1	0	0	1	0	0	0	0
10	0	1	0	1	0	0	0	0
11	1	1	0	1	0	0	0	0
12	0	0	1	1	0	0	0	0
13	1	0	1	1	0	0	0	0
14	0	1	1	1	0	0	0	0
15	1	1	1	1	0	0	0	0
16	0	0	0	0	1	0	0	0
17	1	0	0	0	1	0	0	0
18	0	1	0	0	1	0	0	0
19	1	1	0	0	1	0	0	0
20	0	0	1	0	1	0	0	0
21	1	0	1	0	1	0	0	0
22	0	1	1	0	1	0	0	0
23	1	1	1	0	1	0	0	0
24	0	0	0	1	1	0	0	0
25	1	0	0	1	1	0	0	0
26	0	1	0	1	1	0	0	0
27	1	1	0	1	1	0	0	0
28	0	0	1	1	1	0	0	0
29	1	0	1	1	1	0	0	0

30	0	1	1	1	1	0	0	0
31	1	1	1	1	1	0	0	0
32	0	0	0	0	0	1	0	0
...	...	...	...	...	...	...	...	...
253	1	0	1	1	1	1	1	1
254	0	1	1	1	1	1	1	1

• **Cable Definition**

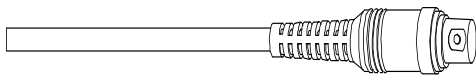

BNC Connector

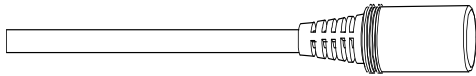

Power Connector

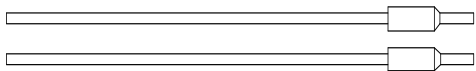

Red:RS485A  
Yellow:RS485B

BNC Connector :Video Coaxial Cable

Power Connector: DC12V

Red: RS485A

Yellow: RS485B

## 6 Operation Instructions

● **Main Functions Fast Call Up**

Our IR Speed dome supports 220 preset positions. You can activate some special functions by calling upon code number 65-99.

Serial No.	Command	Fast Call Up	Note
1	Start Auto Scan	Call 99	Default to start auto scan of group No.1
2	Start Auto Cruise	Call 98	Default to start auto cruise of group No.1
3	Start Pattern Tour	Call 97	Default to start pattern tour of group No.1

4	Start Auto Scan of Group No.	Call 80+ Call pp+ Call 99	pp means: Group No.1-8
5	Start Auto Cruise of Group No.	Call 80+ Call pp+ Call 98	
6	Start Pattern Tour of Group No.	Call 80+ Call pp+ Call 97	pp means: Group No.1-4
7	Stop Auto Mode/End up Setting	Call 96	
8	Open OSD Menu	Set 95 (or Call 95)	
9	Remote Reset	Call 94	
10	Recover Factory Default	Call 82	

**•System Self-Testing**

The dome will do self-testing after power up, and system status will show “Normal” if system is running normally. If error happens, testing result will be shown in “o” or “X”. “o” means normal and “X” means error. Please check the according meaning as follow.

**•OSD Menu Operations**



Call Preset 95 to enter the main OSD menu (or call preset No.1 two times continuously within two seconds)



Control the joystick to move the cursor around the menu



Press “Iris Open” to enter the menu for selections



Move the joystick up and down to select the item



Press “Iris Open” to confirm the selection

No.	1	2	3	4	5	6
Meaning	Dip Switch	Temperature Sensor	Storage	Pan	Tilt	Camera



Close” to cancel the selection

**\*Note: If your controller does not have a joystick, use the up or down key.**

**• INFORMATION**

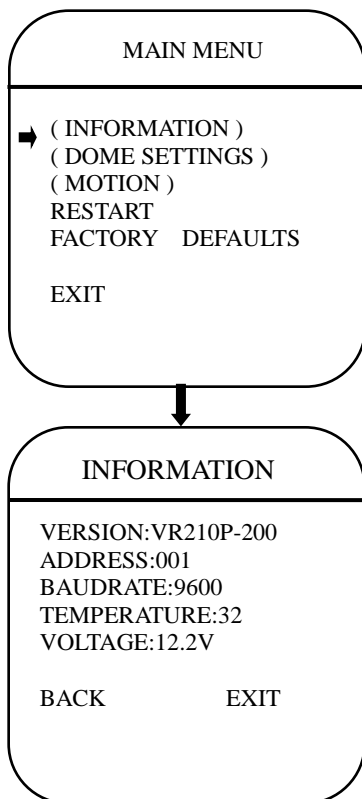

The user can check the dome system information as required. The system information includes: Version, dome address, baud rate, temperature, voltage.

**Use the following steps to display the System Information screens:**

- 1) Use the joystick to position the cursor along the INFORMATION.
- 2) Press Iris Open. The INFORMATION screen opens.
- 3) Mover the joystick up and town to select the item.
- 4) Press Iris Open to enter the setup of each item.





• **IR LED**

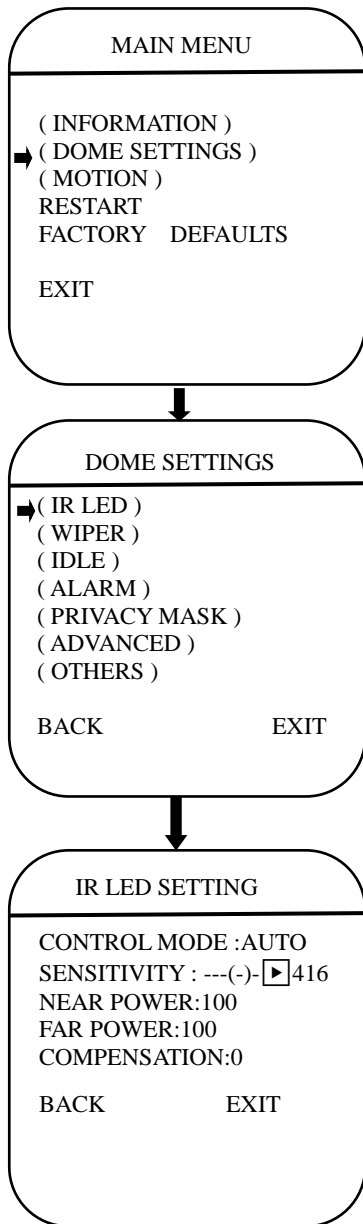

The user can open and close the IR LED manually and set up the IR LED work mode under this OSD mean. (Under normal operation mode, the user can press IRIS OPEN and IRIS CLOSE to adjust the IR LED power):

1) **CONTROL MODE:**

<b>AUTO</b>	IR LED will be opened or closed automatically according to the light conditions.
<b>TIMING</b>	LED will be adjusted according to Open and Close Time.
<b>OPEN</b>	IR LED forcedly open
<b>CLOSE</b>	IR LED forcedly close
<b>CAMERA</b>	IR LED status (Open/Close) will be synchronized with Camera day and night switching

2) **SENSITIVITY:**

Here the user can manually set the sensitivity from 1-5. The smaller the number is, the lower light of the environment will be when the IR LED on.

3) **NEAR POWER: 100**

4) **FAR POWER: 100**

5) **COMPENSATION: 0**

• **WIPER**

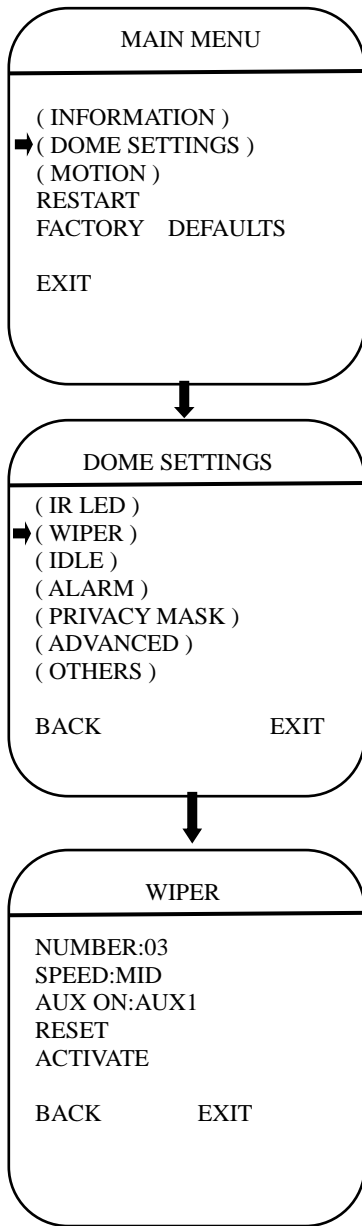

The user can make adjustment for the wiper under this menu (suitable for wiper-equipped dome)

- 1) **Numbers** : Move the cursor to “NUMBER” and press IRIS OPEN to enter the setup of Wiper Number. Move the joystick up and down to select number (1-10), then press IRIS OPEN to confirm.
- 2) **Speed**: Move the cursor to “SPEED” and IRIS OPEN to enter the setup of Wiper speed. Move the joystick up and down to select “HIGH” ,“MID ”OR “ LOW”, the press IRIS OPEN to confirm.
- 3) **Start** : Move the cursor and press IRIS OPEN to start wiper.

•IDLE

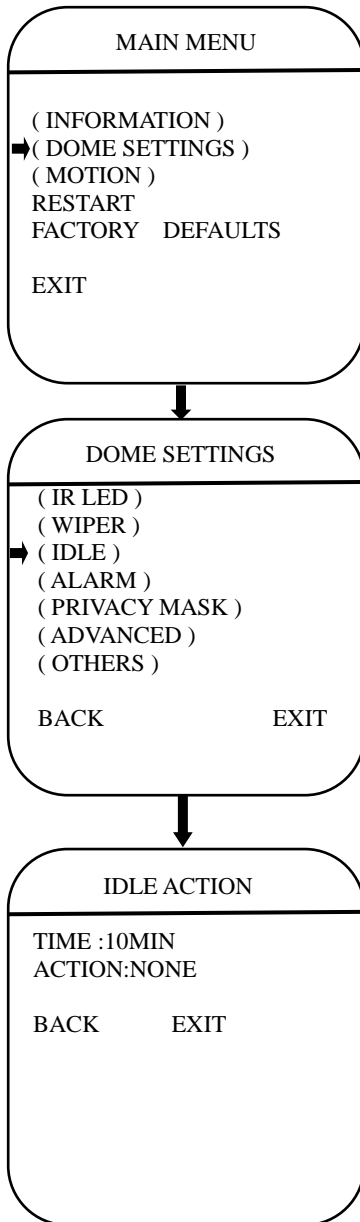

IDLE setting means if there is no command for the dome for a period of time, the dome will run the actions as defined.

1) **TIME:** Move the cursor to “TIME” and press IRIS OPEN to enter, and move the joystick up and dome to select among 30 sec, 1 min, 5 min, 10 min and 30 min. And press IRIS OPEN to confirm.

2) **ACTION:** Move the cursor to “ACTION” and press IRIS OPEN to enter. Move the joystick to select the actions including” NONE, PRESET, SCAN, SEQUENCE, PATTERN. Press IRIS OPEN to confirm.

**•ALARM**

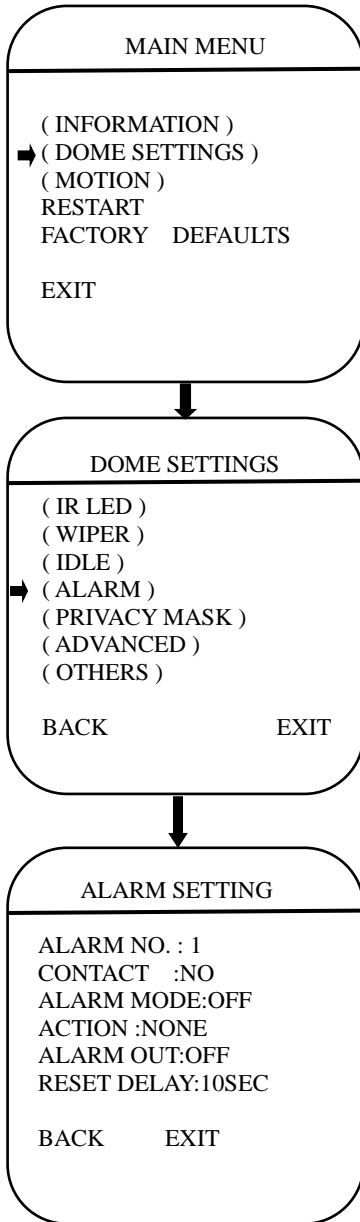

The dome system has 2 alarm inputs and 1 alarm output. (optional function). When an alarm is received, an input signal to the dome triggers the user defined action (such as presets, patterns, etc.), and at meantime the alarm output signals is activated.

**ALARM NO.:** Move the cursor to the ALARM NO. Press IRIS OPEN to enter and move the joystick up and down to select the alarm input no. (Channel 1 and Channel 2)

**INPUT STATE:** Set the alarm contact status. There are two input states, OPEN and CLOSE.

**ALARM MODE:**

NONE	(default) No action
PRESET	Dome goes to preset. (Default as Preset 1)
SCAN	Dome starts auto scan (Default as Auto Scan 1)
SEQ	Dome runs auto cruise (Default as Auto Cruise 1)
PATTERN	Dome runs pattern (Default as Pattern 1)

**ACTION: Set the alarm action:**

OFF	Alarm function is deactivated.
ON	Alarm function is activated.
AUTO	AUTO Alarm function will be activated and deactivated between START TIME and STOP TIME.

**ALARM OUT: Set the auxiliary to activate:**

OFF	Not alarm output will be activated.
OUT1	An alarm action will close AUX 1 output..
OUT2	An alarm action will activate AUX2 output.

**RESET TIME:** Set up time for the alarm output (such as an alarm buzzed) when is triggered by the detector.

**START /STOP TIME:** Set up the time to start alarm and stop alarm ONLY under the AUTO mode under ALARM MODE.

• **PRIVACY MASK**

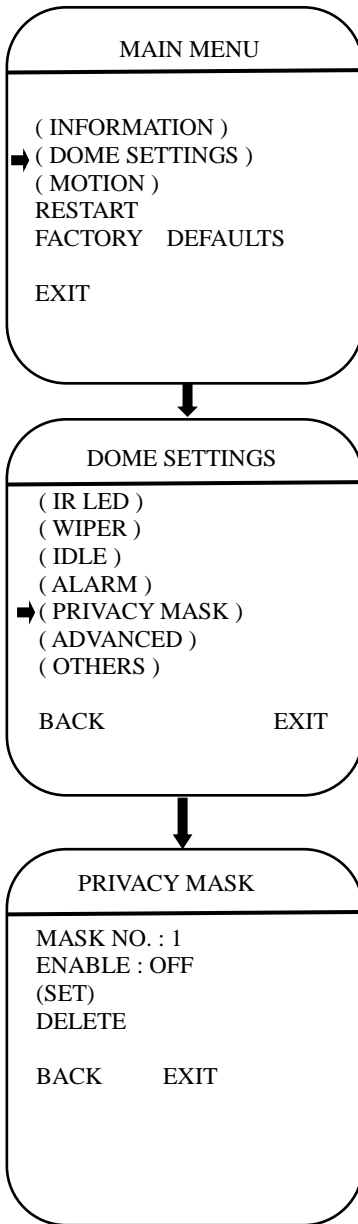

Privacy mask allows the user to mask the privacy areas with black frame. The user can set up 8 privacy masks at most.

**MASK NO.:** Move the cursor here and press IRIS OPEN to enter the setup of Mask Number of the privacy zone.

**ENABLE:** To enable or disable this privacy mask function.

**SET:** Move the cursor here and press IRIS OPEN to enter the mode of setting the privacy mask. Move the joystick (Left/Right/Up/Down) on the screen to set up the privacy zone and press IRIS OPEN to confirm.

**DELETE:** Move the cursor here and press IRIS OPEN to delete the current No. of privacy mask zone.

•OTHERS

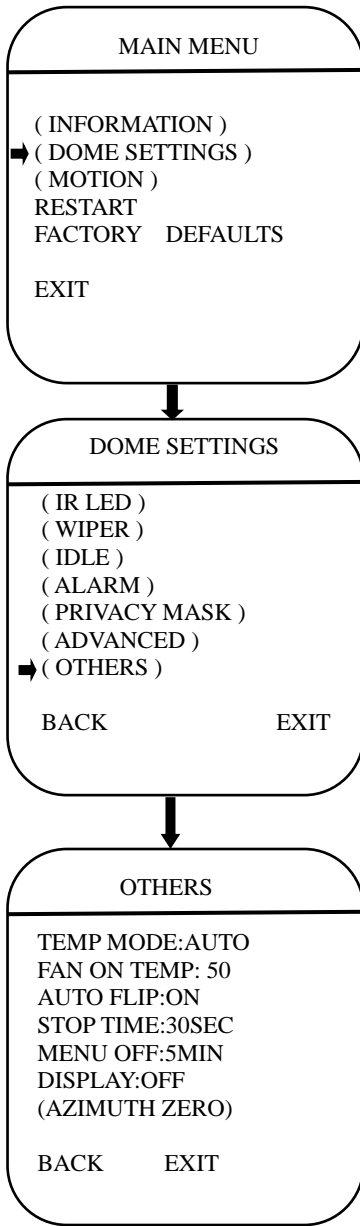

The user can set up TEMP MODE, INTERNAL FAN, PRESET FREEZE, STOP TIME. MENU OFF TIME and NORTH ZERO here under the menu of "OTHERS"

**TEMP MODE:** To set up the control mode of dome fans and heaters. It includes three modes of AUTO, FAN HIGH SPEED and FAN LOW SPEED.

**PRESET FREEZE:** This feature freezes the scene on the monitor when going to a preset. This allows smooth switching from one preset scene to another.

**AUTO FLIP:** When the camera tilts downward and goes just beyond the vertical position, the camera will rotate 180 degrees. The user can press IRIS OPEN to enter and choose to turn on/off this function.

**STOP TIME:** To set up the time that dome will stops after receiving the last command. Options include 5/15/30/60 Sec.

**MENU OFF TIME:** To set up the time that OSD menu be off when no operations. Options include 1/2/5/10 min.

**NORTH ZERO:** To set up the due north of the dome (pan 0°) Move the cursor here and press IRIS OPEN to enter. Move the joystick to control the dome to pan 0° and press IRIS OPEN to confirm.

•AUX

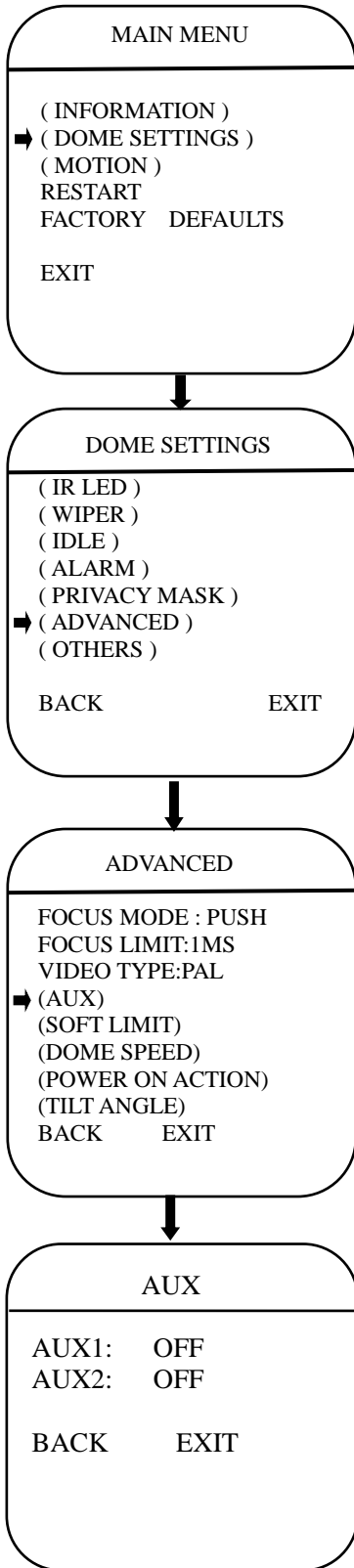

The user can set up the auxiliary output to trigger other devices from an alarm or a controller.  
Move the cursor to AUX and press IRIS OPEN to enter to select "ON" or "OFF" to enable or disable this function.



•**SOFT LIMIT**

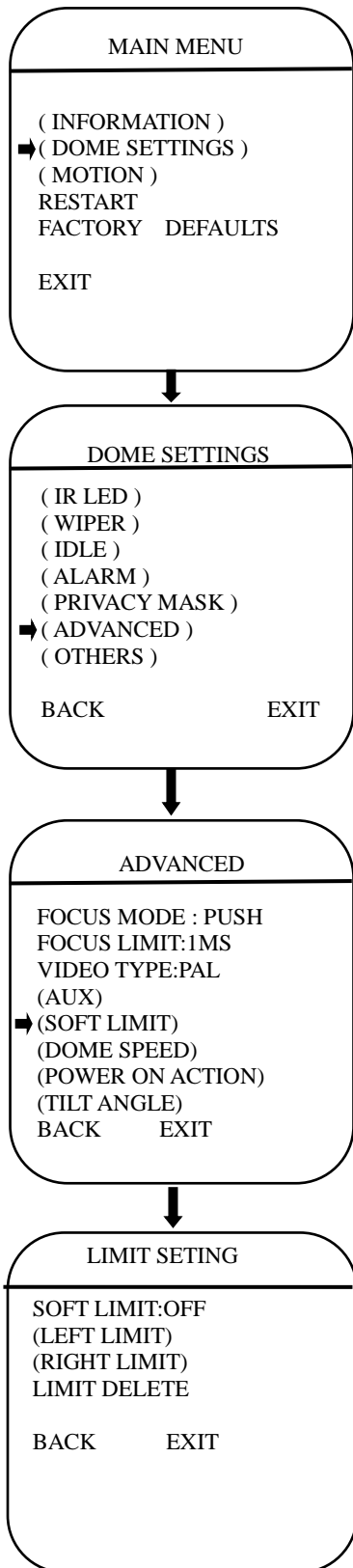

The user can set up the soft limit to define the left and right boundaries for the pan movement.

**SOFT LIMIT:** Move the cursor here and press IRIS OPEN to enter. Move the joystick to select “ON” or “OFF” to enable or disable this function.

**LEFT LIMIT:** Move the cursor here and press IRIS OPEN to enter. Now the user can move the joystick to control the PAN movement of the dome to a defined position for the left limit. Press IRIS OPEN to confirm.

**RIGHT LIMIT:** Move the cursor here and press IRIS OPEN to enter. Now the user can move the joystick to control the PAN movement of the dome to a defined position for the right limit. Press IRIS OPEN to confirm.

**LIMIT DELETE:** Move the cursor here and press IRIS OPEN to delete all the settings.

•**DOME SPEED**

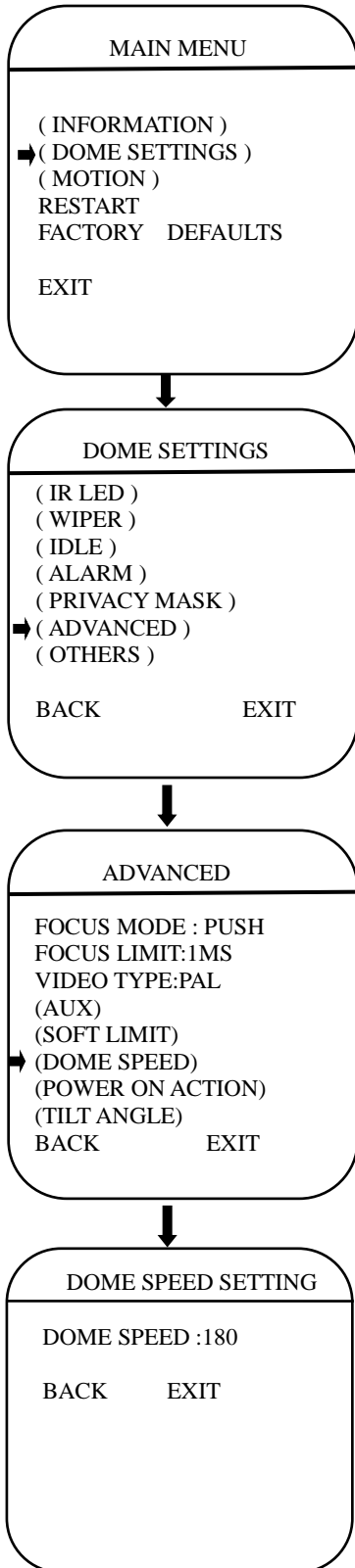

To make a selection of the dome speed, the user can enter this menu to set up.  
Move the cursor to DOME SPEED and press IRIS OPEN to enter.  
Move the joystick to select the dome speed when doing the pan movement.  
Move the cursor to BACK/EXIT and press IRIS OPEN to run the command of BACK or EXIT.

**•POWER ON ACTION**

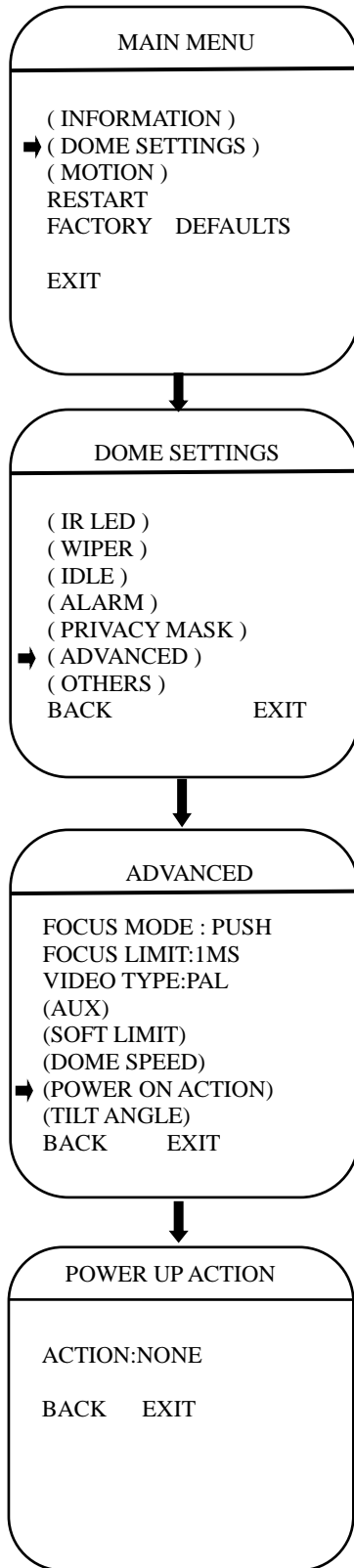

The user can define the dome action when power on, Move the cursor to POWER ON ACTION and press IRIS OPEN to enter the mode of setup.

NONE	(default) No action
PRESET	Dome goes to preset. (Default as Preset 1)
SCAN	Dome starts auto scan (Default as Auto Scan 1)
SEQ	Dome runs auto cruise (Default as Auto Cruise 1)
PATTERN	Dome runs pattern (Default as Pattern 1)

**•CTIT ANGLE**

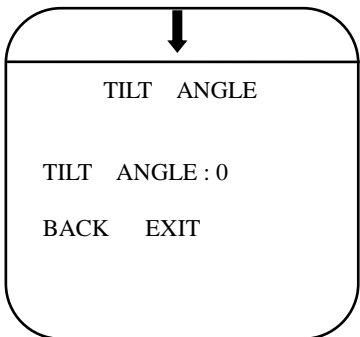
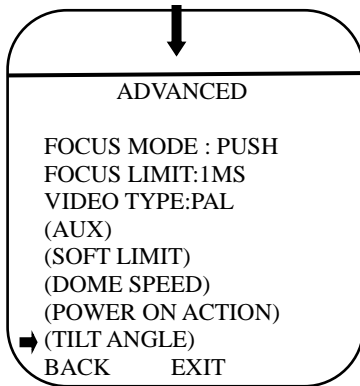
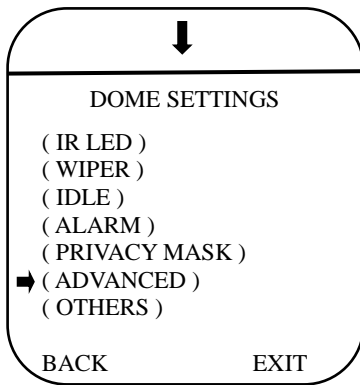
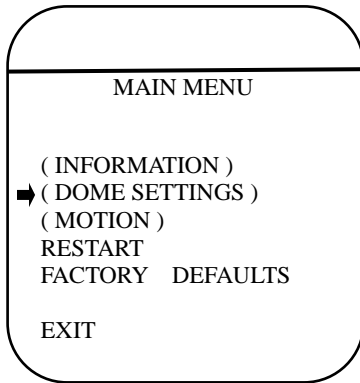

The user can set up the tilt angle under the menu of TILT ANGLE.

Move the cursor to “TILT ANGLE” and press IRIS OPEN to the setup of tilt angle . Move the joystick up and down to select the angle and press the IRIS OPEN to confirm.

• **MOTION**

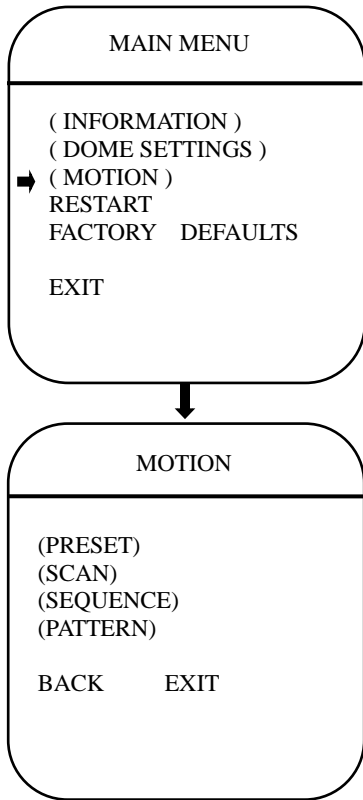

The user can set up 4 motion detection scenes under this menu.

**PRESET:** The dome supports 220 presets.

**SCAN:** The dome supports 8 groups of auto scan.

**SEQUENCE:** The dome supports 8 groups of auto cruise and each cruise supports 32 presets.

**PATTERN:** The dome supports 4 pattern tours and each pattern cover at most 10 Minutes of 500 commands.

•**PRESET**

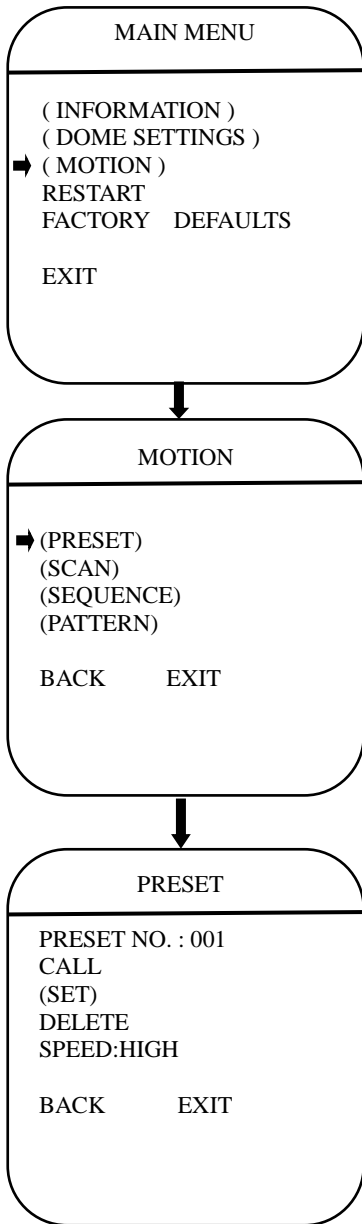

The dome supports 220 presets. Please check the following steps to set up a preset.

- 1) **PRESET NO.:** Move the cursor here and press IRIS OPEN to enter the setup of Preset Number. Move the joystick to select a preset number (1-64 and 100-255) and press IRIS OPEN to confirm.
- 2) **<SET>:** Move the cursor here and press IRIS OPEN to enter. Move the dome to a defined position as preset point and press IRIS OPEN to save the preset position.
- 3) **CALL:** Move the cursor here and press IRIS OPEN to call up the current preset.
- 4) **DELETE:** Move the cursor here and press IRIS OPEN to delete the current preset.
- 5) **SPEED:** Move the cursor here and press IRIS OPEN to set up the preset call up speed of LOW, MID and HIGH.

•**SCAN**

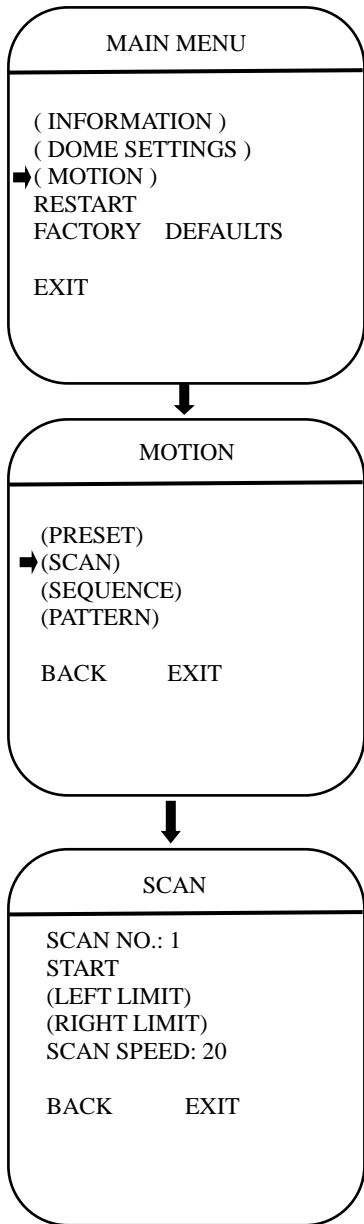

The dome supports 8 groups of auto scan. Please check the following steps to set up a scan.

- 1) **SCAN NO.:** Move the cursor here and press IRIS OPEN to enter the setup of SCAN Number. Move the joystick to select a preset number (1-8) and press IRIS OPEN to confirm.
- 2) **TITLE:** Move the cursor here and press IRIS OPEN to enter the setup of SCAN Title. Check the detailed above in DOME TITLE settings.
- 3) **<LEFT LIMIT>:** Move the cursor here and press IRIS OPEN to enter. Move the dome to a defined position as left limit and press IRIS OPEN to save this left boundary.
- 4) **<RIGHT LIMIT>:** Move the cursor here and press IRIS OPEN to enter. Move the dome to a defined position as right limit and press IRIS OPEN to save this right boundary.
- 5) **START:** Move the cursor here and press IRIS OPEN to start the current scan.
- 6) **SCAN SPEED:** Move the cursor here and press IRIS OPEN to set up the scan speed ranging 1-20.

•**SEQUENCE**

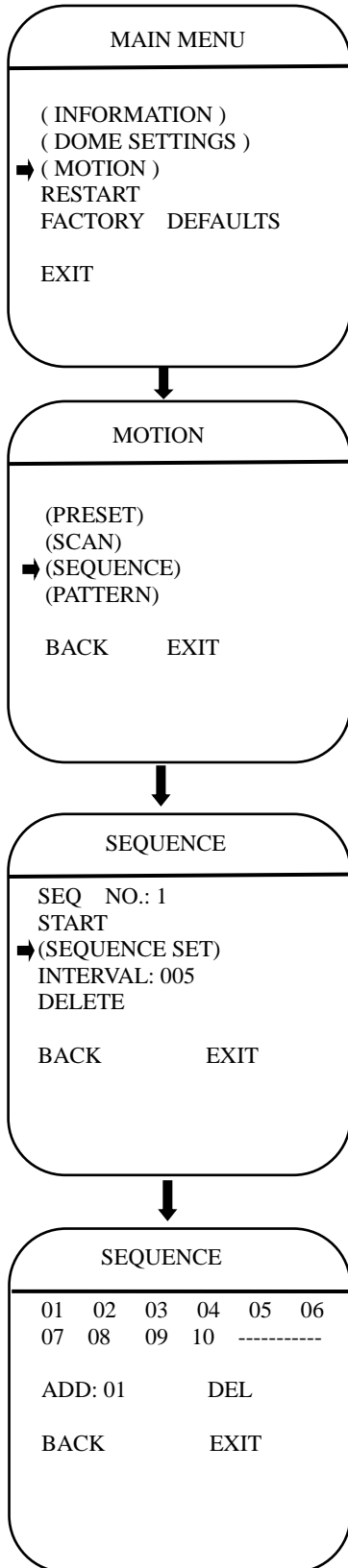

The dome supports 8 groups of auto cruise and each cruise supports 32 presets. . Please check the following steps to set up cruise.

- 1) **SEQ NO.:** Move the cursor here and press IRIS OPEN to enter the setup of Sequence Number. Move the joystick to select a preset number (1-8) and press IRIS OPEN to confirm.
- 2) **TITLE:** Move the cursor here and press IRIS OPEN to enter the setup of Sequence Title. Check the detailed above in DOME TITLE Settings.

- 3) **<SEQUENCE SET>:** Move the cursor here and press IRIS OPEN to enter. Move the cursor to EDIT and press IRIS OPEN enter edit mode of sequence. Move the joystick left and right to select each item.

- a) When the < > is on the item NO., move joystick up or down to select the Serial NO. of the preset in a sequence. There are up to 32 presets in each sequence.
- b) When the < > is on the item PRESET, move the joystick up or down to select the preset NO. that the user wants to add in the sequence.
- c) When the < > is on the INTERVAL, move the joystick up or down to select the interval time between each preset.
- d) When the < > is on the last item, move the joystick up or down to select edition mode as “INS (insert)”, “ok” and “delete”.

Press IRIS OPEN when selecting INS to insert the settings into the position of current Serial No.

Press IRIS OPEN when selecting OK to override the settings of Current Serial No.

Press IRIS OPEN when selecting delete to delete the settings of the Current Serial No.

Press IRIS OPEN to save all the setting and press IRIS CLOSE to exit.

- 4) **DELETE/START:** Move the cursor here and press IRIS OPEN to delete/start the current sequence.



•**PATTERN**

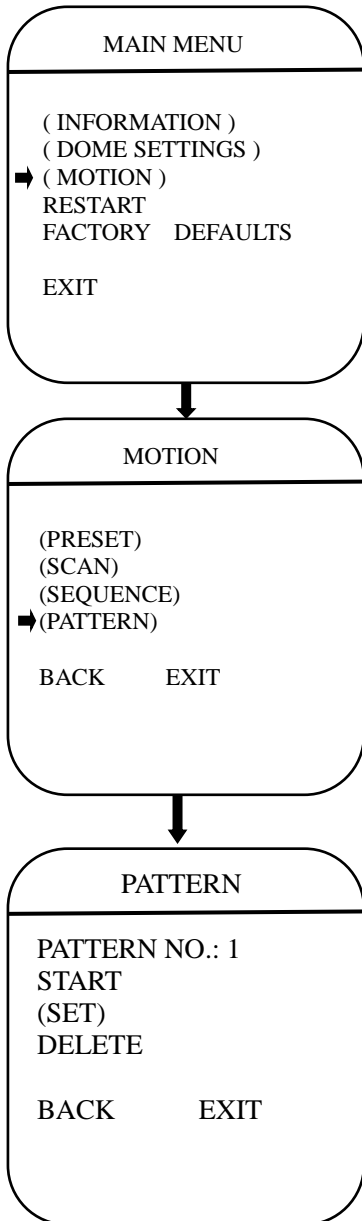

The dome supports 4 pattern tours and each pattern cover at most 10 Minutes of 500 commands. Please check the following steps to set up a pattern.

- 1) **PATTERN NO.:** Move the cursor here and press IRIS OPEN to enter the setup of Pattern Number. Move the joystick to select a pattern number (14) and press IRIS OPEN to confirm.
- 2) **<SET>:** Move the cursor here and press IRIS OPEN to enter. Move the dome up/down/left/right, make the zoom in/out and press IRIS OPEN to save the pattern tour.
- 3) **START:** Move the cursor here and press IRIS OPEN to start the current pattern tour.
- 4) **DELETE:** Move the cursor here and press IRIS OPEN to delete the current pattern tour.

•**RESTART**

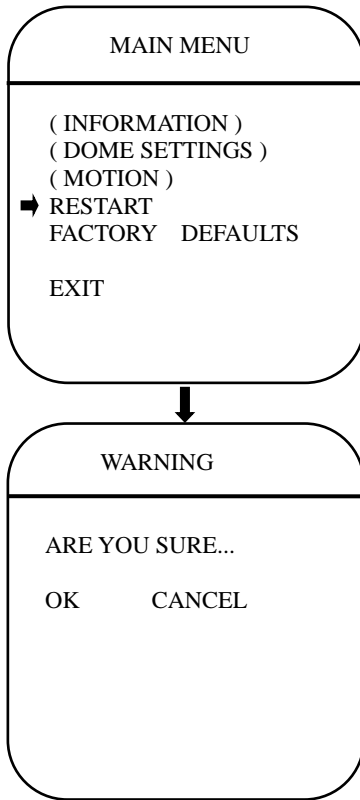

**TRACKING SCENE SET:** Here the user can set up the scene that the dome will get back to when finishing the action of auto tracking. Move the cursor here and press IRIS OPEN to enter. Move the dome to the wanted scene and press IRIS OPEN to confirm.

**DELETE:** Move the cursor here and press IRIS OPEN to delete the return scene.

**RETURN DELAY:** To set up the time that dome will waiting to return to this scene.

**RESTART:**The dome allows the user to reset its settings remotely under this menu.

Move the cursor here and press IRIS OPEN to enter. Select "OK" or "CANCEL" to continue the reset or cancel the reset.

• **FACTORY DEFAULTS**

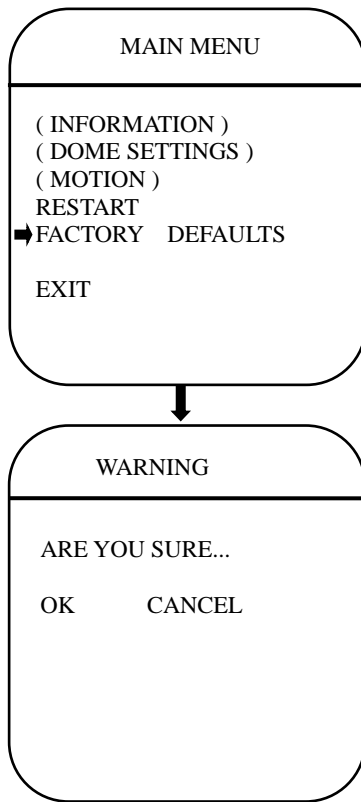

FACTORY DEFAULTS will allow the user to recover all the setting to factory default setting.

Move the cursor here and press IRIS OPEN to enter. Select “OK” or “CANCEL” to continue the reset or cancel the reset.

## 7 After- sales service

For speed dome production in our company, our company promises one year warranty. Under warranty, maintenance service is provided for free. But for the ***following situations***, material and manual cost need to be paid.

- Don't operate in accordance with 《User's Manual》 to cause damage.
- The damage caused by force majeure factors such as lighting and fire, etc
- The damage caused by other manufacturer's poor design and matching problem

### \*The Company Statement

- Because our company continuously adopt new technologies, product parameters change without prior notice.
- The final interpretation of operation instructions belong to our company.

## 8 APPENDIX: Lighting and surge protection

This product USES the gas discharge tube of TVS diode and protection circuit, can effectively prevent the 3.0 kV following transient lightning and surge lamp all types of pulse signal to the damage of equipment. But, for outdoor installation according to the actual situation on the premise of guarantee the electrical safety to do the necessary protective measures:

- Signal transmission line must be with the high voltage equipment goods between high voltage cable to keep a distance of at least 50 meters
- Choose as far as possible outside wiring along the roof line
- For open field must adopt sealing pipe buried wiring way, and the steel pipe by one-point earthing, absolutely forbidden by wiring overhead way
- In strong thunderstorms or high induction voltage region (e.g., high voltage transformer substation), must be taken to add extra high power lightning protection equipment and installation of lightning rod and other measures
- Lightning protection and grounding design of outdoor installation and wiring must be combined with the construction of lightning protection requirements into consideration, and conform to the requirements of relevant national standards and industry standards.
- The system must be equipotential grounding. Grounding device must meet the system anti-interference and electrical safety requirements, and shall not be short term or mixed with strong power grid zero line. System separate grounding, grounding resistance is not greater than  $4\Omega$ .

